

TL3474, TL3474A

HIGH-SLEW-RATE, SINGLE-SUPPLY OPERATIONAL AMPLIFIERS

SLVS461B – JANUARY 2003 – REVISED JULY 2003

- Low Offset . . . 3 mV (Max) for A-Grade
- Wide Gain-Bandwidth Product . . . 4 MHz
- High Slew Rate . . . 13 V/ μ s
- Fast Settling Time . . . 1.1 μ s to 0.1%
- Wide-Range Single-Supply Operation . . . 4 V to 36 V
- Wide Input Common-Mode Range Includes Ground (V_{CC-})
- Low Total Harmonic Distortion . . . 0.02%
- Large-Capacitance Drive Capability . . . 10,000 pF
- Output Short-Circuit Protection
- Alternative to MC33074/A and MC34074/A

D, N, OR PW PACKAGE
(TOP VIEW)

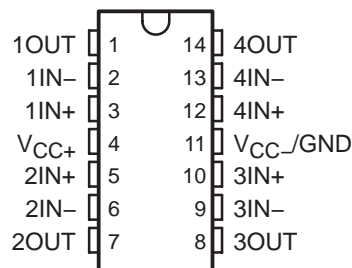

description/ordering information

ORDERING INFORMATION

T_A	V_{IOmax} AT 25°C	PACKAGE†		ORDERABLE PART NUMBER	TOP-SIDE MARKING
0°C to 70°C	A-grade: 3 mV	PDIP (N)	Tube of 25	TL3474ACN	TL3474ACN
		SOIC (D)	Tube of 50	TL3474ACD	TL3474A
			Reel of 2500	TL3474ACDR	
	TSSOP (PW)	Tube of 90	TL3474ACPW	T3474A	
		Reel of 2000	TL3474ACPWR		
	0°C to 70°C	Standard grade: 10 mV	PDIP (N)	Tube of 25	TL3474CN
SOIC (D)			Tube of 50	TL3474CD	TL3474C
			Reel of 2500	TL3474CDR	
TSSOP (PW)		Tube of 90	TL3474CPW	TL3474	
		Reel of 2000	TL3474CPWR		
-40°C to 105°C		A-grade: 3 mV	PDIP (N)	Tube of 25	TL3474AIN
	SOIC (D)		Tube of 50	TL3474AID	TL3474AI
			Reel of 2500	TL3474AIDR	
	TSSOP (PW)	Tube of 90	TL3474AIPW	Z3474A	
		Reel of 2000	TL3474AIPWR		
	Standard grade: 10 mV	PDIP (N)	Tube of 25	TL3474IIN	TL3474IIN
SOIC (D)		Tube of 50	TL3474IID	TL3474I	
		Reel of 2500	TL3474IIDR		
TSSOP (PW)	Tube of 90	TL3474IPW	Z3474		
Reel of 2000	TL3474IPWR				

† Package drawings, standard packing quantities, thermal data, symbolization, and PCB design guidelines are available at www.ti.com/sc/package.



Please be aware that an important notice concerning availability, standard warranty, and use in critical applications of Texas Instruments semiconductor products and disclaimers thereto appears at the end of this data sheet.

PRODUCTION DATA information is current as of publication date. Products conform to specifications per the terms of Texas Instruments standard warranty. Production processing does not necessarily include testing of all parameters.

**TEXAS
INSTRUMENTS**

POST OFFICE BOX 655303 • DALLAS, TEXAS 75265

Copyright © 2003, Texas Instruments Incorporated

TL3474, TL3474A HIGH-SLEW-RATE, SINGLE-SUPPLY OPERATIONAL AMPLIFIERS

SLVS461B – JANUARY 2003 – REVISED JULY 2003

description/ordering information (continued)

Quality, low-cost, bipolar fabrication with innovative design concepts is employed for the TL3474, TL3474A operational amplifiers. These devices offer 4 MHz of gain-bandwidth product, 13-V/ μ s slew rate, and fast settling time without the use of JFET device technology. Although the TL3474 and TL3474A can be operated from split supplies, they are particularly suited for single-supply operation because the common-mode input voltage range includes ground potential (V_{CC-}). With a Darlington transistor input stage, these devices exhibit high input resistance, low input offset voltage, and high gain. The all-npn output stage, characterized by no dead-band crossover distortion and large output voltage swing, provides high-capacitance drive capability, excellent phase and gain margins, low open-loop high-frequency output impedance, and symmetrical source/sink ac frequency response. These low-cost amplifiers are an alternative to the MC34074/A and MC33074/A operational amplifiers.

schematic (each amplifier)

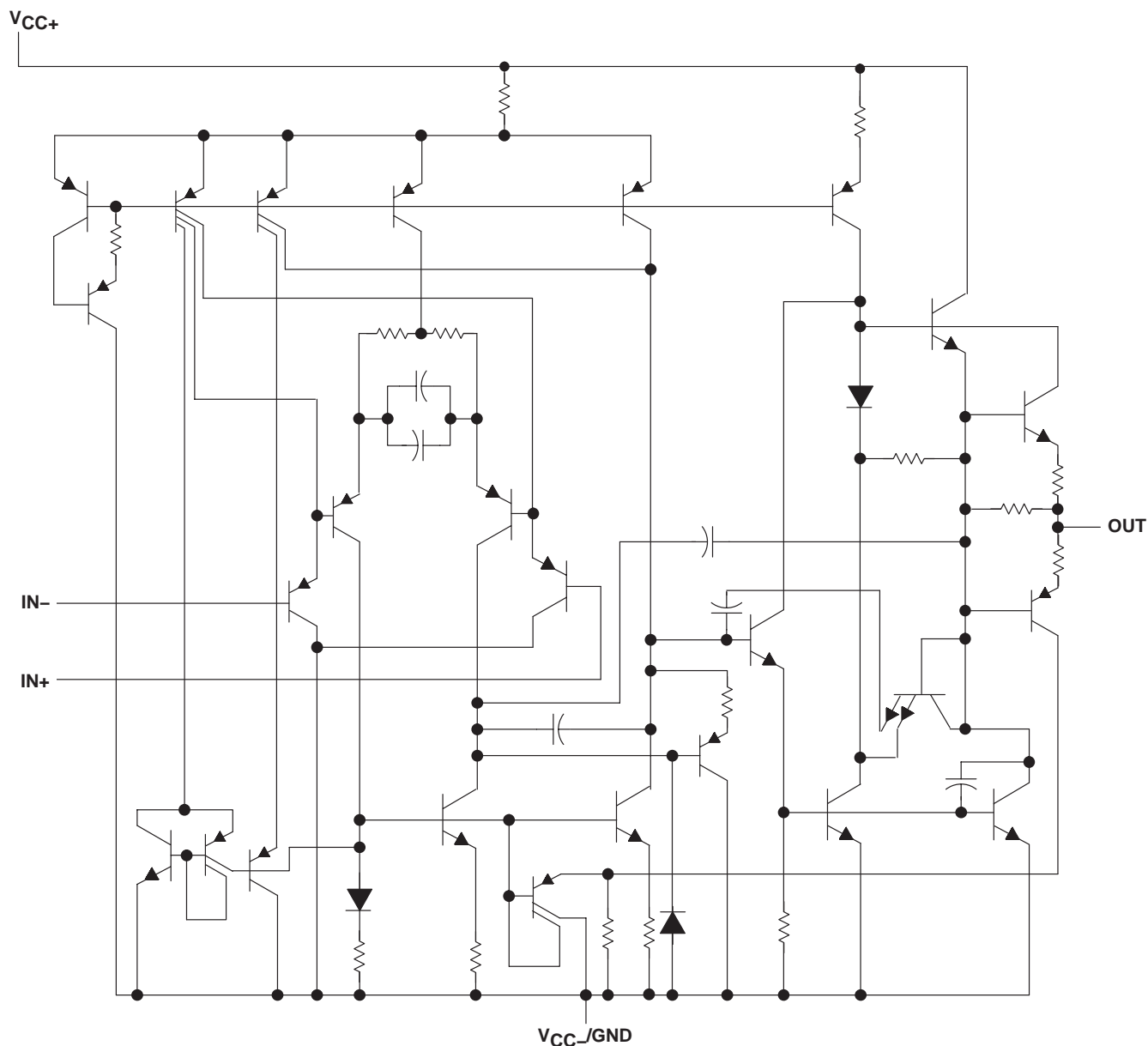

TL3474, TL3474A

HIGH-SLEW-RATE, SINGLE-SUPPLY OPERATIONAL AMPLIFIERS

SLVS461B – JANUARY 2003 – REVISED JULY 2003

absolute maximum ratings over operating free-air temperature range (unless otherwise noted)†

Supply voltage: V_{CC+} (see Note 1)	18 V
V_{CC-}	-18 V
Differential input voltage, V_{ID} (see Note 2)	±36 V
Input voltage, V_I (any input)	$V_{CC±}$
Input current, I_I (each input)	±1 mA
Output current, I_O	±80 mA
Total current into V_{CC+}	80 mA
Total current out of V_{CC-}	80 mA
Duration of short-circuit current at (or below) 25°C (see Note 3)	Unlimited
Package thermal impedance, θ_{JA} (see Notes 4 and 5): D package	86°C/W
N package	80°C/W
PW package	113°C/W
Operating virtual junction temperature, T_J	150°C
Lead temperature 1.6 mm (1/16 inch) from case for 10 seconds	260°C
Storage temperature range, T_{stg}	-65°C to 150°C

† Stresses beyond those listed under “absolute maximum ratings” may cause permanent damage to the device. These are stress ratings only, and functional operation of the device at these or any other conditions beyond those indicated under “recommended operating conditions” is not implied. Exposure to absolute-maximum-rated conditions for extended periods may affect device reliability.

- NOTES:
1. All voltage values, except differential voltages, are with respect to the midpoint between V_{CC+} and V_{CC-}/GND .
 2. Differential voltages are at the noninverting input with respect to the inverting input. Excessive input current can flow when the input is less than $V_{CC-} - 0.3$ V.
 3. The output can be shorted to either supply. Temperature and/or supply voltages must be limited to ensure that the maximum dissipation rating is not exceeded.
 4. Maximum power dissipation is a function of $T_J(max)$, θ_{JA} , and T_A . The maximum allowable power dissipation at any allowable ambient temperature is $P_D = (T_J(max) - T_A)/\theta_{JA}$. Operating at the absolute maximum T_J of 150°C can affect reliability.
 5. The package thermal impedance is calculated in accordance with JEDEC 51-7.

recommended operating conditions

		MIN	MAX	UNIT	
$V_{CC±}$	Supply voltage	4	36	V	
V_{IC}	Common-mode input voltage	$V_{CC} = 5$ V	0	2.8	V
		$V_{CC±} = ±15$ V	-15	12.8	
T_A	Operating free-air temperature	TL3474C, TL3474AC	0	70	°C
		TL3474I, TL3474AI	-40	105	



TL3474, TL3474A HIGH-SLEW-RATE, SINGLE-SUPPLY OPERATIONAL AMPLIFIERS

SLVS461B – JANUARY 2003 – REVISED JULY 2003

electrical characteristics at specified free-air temperature, $V_{CC\pm} = \pm 15\text{ V}$ (unless otherwise noted)

PARAMETER	TEST CONDITIONS	T_A	TL3474			TL3474A			UNIT
			MIN	TYP†	MAX	MIN	TYP†	MAX	
V_{IO} Input offset voltage	$V_{IC} = 0$, $V_O = 0$, $R_S = 50\ \Omega$	$V_{CC} = 5\text{ V}$	25°C	1.5	10	1.5	3	mV	
		$V_{CC} = \pm 15\text{ V}$	25°C	1.0	10	1.0	3		
			Full range‡			12			5
αV_{IO} Temperature coefficient of input offset voltage	$V_{IC} = 0$, $V_O = 0$, $R_S = 50\ \Omega$	$V_{CC} = \pm 15\text{ V}$	Full range‡	10		10		$\mu\text{V}/^\circ\text{C}$	
I_{IO} Input offset current		$V_{CC} = \pm 15\text{ V}$	25°C	6	75	6	75	nA	
			Full range‡		300		300		
I_{IB} Input bias current	$V_{CC} = \pm 15\text{ V}$	25°C	100	500	100	500	nA		
		Full range‡		700		700			
V_{ICR} Common-mode input voltage range	$R_S = 50\ \Omega$	25°C	-15 to 12.8		-15 to 12.8		V		
		Full range‡	-15 to 12.8		-15 to 12.8				
V_{OH} High-level output voltage	$V_{CC+} = 5\text{ V}$, $V_{CC-} = 0$, $R_L = 2\text{ k}\Omega$	25°C	3.7	4	3.7	4	V		
	$R_L = 10\text{ k}\Omega$	25°C	13.6	14	13.6	14			
	$R_L = 2\text{ k}\Omega$	Full range‡	13.4		13.4				
V_{OL} Low-level output voltage	$V_{CC+} = 5\text{ V}$, $V_{CC-} = 0$, $R_L = 2\text{ k}\Omega$	25°C	0.1	0.3	0.1	0.3	V		
	$R_L = 10\text{ k}\Omega$	25°C	-14.7	-14.3	-14.7	-14.3			
	$R_L = 2\text{ k}\Omega$	Full range‡		-13.5		-13.5			
A_{VD} Large-signal differential voltage amplification	$V_O = \pm 10\text{ V}$, $R_L = 2\text{ k}\Omega$	25°C	25	100	25	100	V/mV		
		Full range‡	20		20				
I_{OS} Short-circuit output current	Source: $V_{ID} = 1\text{ V}$, $V_O = 0$	25°C	-10	-34	-10	-34	mA		
	Sink: $V_{ID} = -1\text{ V}$, $V_O = 0$		20	27	20	27			
CMRR Common-mode rejection ratio	$V_{IC} = V_{ICR}(\text{min})$, $R_S = 50\ \Omega$	25°C	65	97	80	97	dB		
k_{SVR} Supply-voltage rejection ratio ($\Delta V_{CC\pm}/\Delta V_{IO}$)	$V_{CC\pm} = \pm 13.5\text{ V}$ to $\pm 16.5\text{ V}$, $R_S = 100\ \Omega$	25°C	70	97	70	97	dB		
I_{CC} Supply current (per channel)	$V_O = 0$, No load	25°C	3.5	4.5	3.5	4.5	mA		
		Full range‡	4.5	5.5	4.5	5.5			
	$V_{CC+} = 5\text{ V}$, $V_O = 2.5\text{ V}$, $V_{CC-} = 0$, No load	25°C	3.5	4.5	3.5	4.5			

† All typical values are at $T_A = 25^\circ\text{C}$.

‡ Full range is 0°C to 70°C for the TL3474C, TL3474AC devices and -40°C to 105°C for the TL3474I, TL3474AI devices.



TL3474, TL3474A

HIGH-SLEW-RATE, SINGLE-SUPPLY OPERATIONAL AMPLIFIERS

SLVS461B – JANUARY 2003 – REVISED JULY 2003

operating characteristics, $V_{CC\pm} = \pm 15\text{ V}$, $T_A = 25^\circ\text{C}$

PARAMETER		TEST CONDITIONS		TL3474			TL3474A			UNIT
				MIN	TYP	MAX	MIN	TYP	MAX	
SR+	Positive slew rate	$V_I = -10\text{ V to } 10\text{ V}$, $R_L = 2\text{ k}\Omega$, $C_L = 300\text{ pF}$	$A_V = 1$	8	10		8	10	$\text{V}/\mu\text{s}$	
SR-	Negative slew rate		$A_V = -1$		13		13			
t_s	Settling time	$A_{VD} = -1$, 10-V step	To 0.1%		1.1		1.1	μs		
			To 0.01%		2.2		2.2			
V_n	Equivalent input noise voltage	$f = 1\text{ kHz}$,	$R_S = 100\ \Omega$		49		49	$\text{nV}/\sqrt{\text{Hz}}$		
I_n	Equivalent input noise current	$f = 1\text{ kHz}$			0.22		0.22	$\text{pA}/\sqrt{\text{Hz}}$		
THD	Total harmonic distortion	$V_{O(PP)} = 2\text{ V to } 20\text{ V}$, $R_L = 2\text{ k}\Omega$, $A_{VD} = 10$, $f = 10\text{ kHz}$			0.02		0.02	%		
GBW	Gain-bandwidth product	$f = 100\text{ kHz}$		3	4		3	4	MHz	
BW	Power bandwidth	$V_{O(PP)} = 20\text{ V}$, $R_L = 2\text{ k}\Omega$, $A_{VD} = 1$, THD = 5.0%			160		160	kHz		
ϕ_m	Phase margin	$R_L = 2\text{ k}\Omega$,	$C_L = 0$		70		70	deg		
		$R_L = 2\text{ k}\Omega$,	$C_L = 300\text{ pF}$		50		50			
	Gain margin	$R_L = 2\text{ k}\Omega$,	$C_L = 0$		12		12	dB		
		$R_L = 2\text{ k}\Omega$,	$C_L = 300\text{ pF}$		4		4			
r_i	Differential input resistance	$V_{IC} = 0$			150		150	$\text{M}\Omega$		
C_i	Input capacitance	$V_{IC} = 0$			2.5		2.5	pF		
	Channel separation	$f = 10\text{ kHz}$			101		101	dB		
z_o	Open-loop output impedance	$f = 1\text{ MHz}$,	$A_V = 1$		20		20	Ω		

TL3474, TL3474A HIGH-SLEW-RATE, SINGLE-SUPPLY OPERATIONAL AMPLIFIERS

SLVS461B – JANUARY 2003 – REVISED JULY 2003

TYPICAL CHARACTERISTICS ($T_A = 25^\circ\text{C}$ UNLESS OTHERWISE NOTED)

**OUTPUT IMPEDANCE
VS
FREQUENCY**

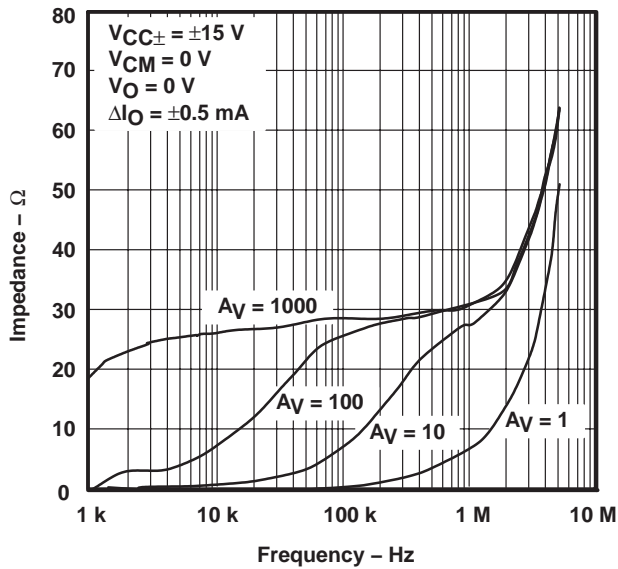

Figure 1

**TOTAL HARMONIC DISTORTION
VS
FREQUENCY**

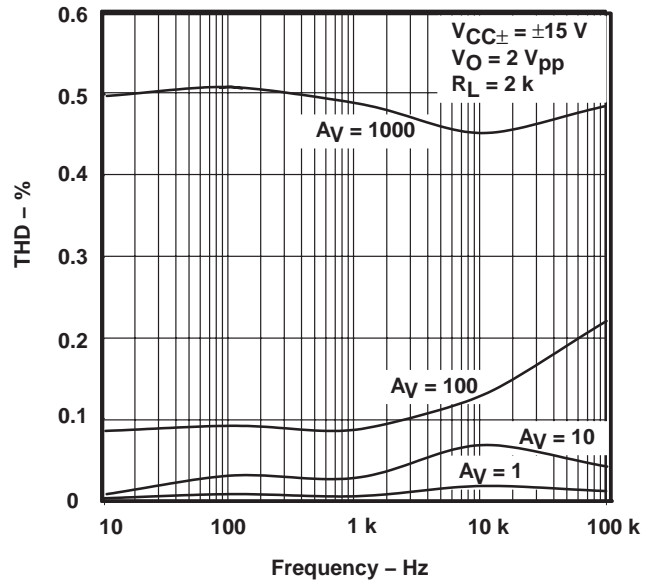

Figure 2

**GAIN AND PHASE
VS
FREQUENCY**

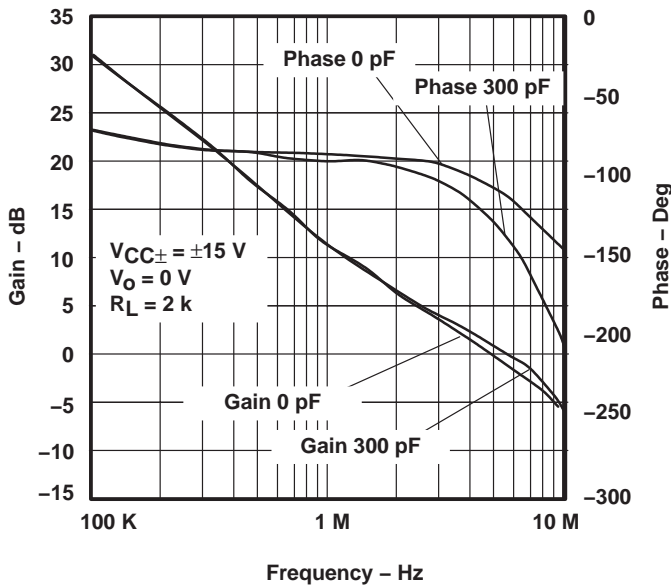

Figure 3

**NORMALIZED INPUT BIAS CURRENT
VS
TEMPERATURE**

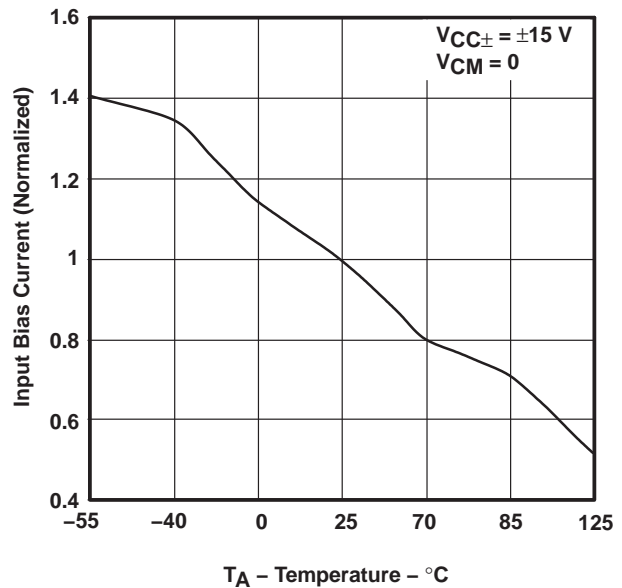

Figure 4



TYPICAL CHARACTERISTICS ($T_A = 25^\circ\text{C}$ UNLESS OTHERWISE NOTED)

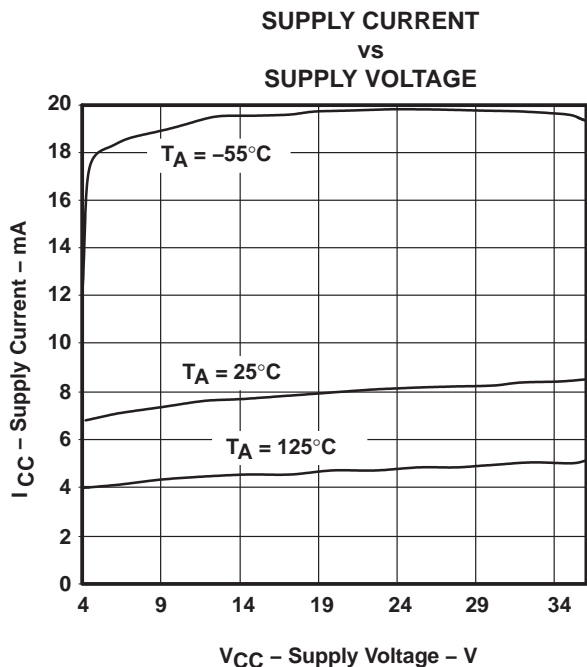

Figure 5

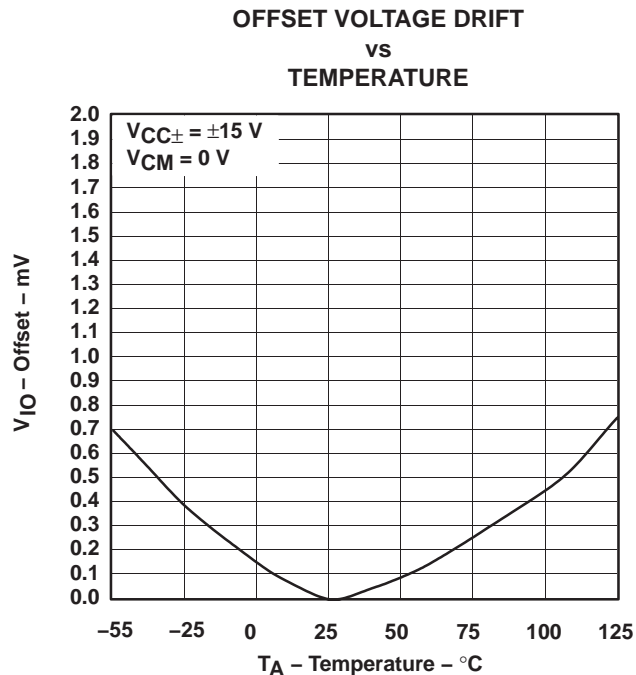

Figure 6

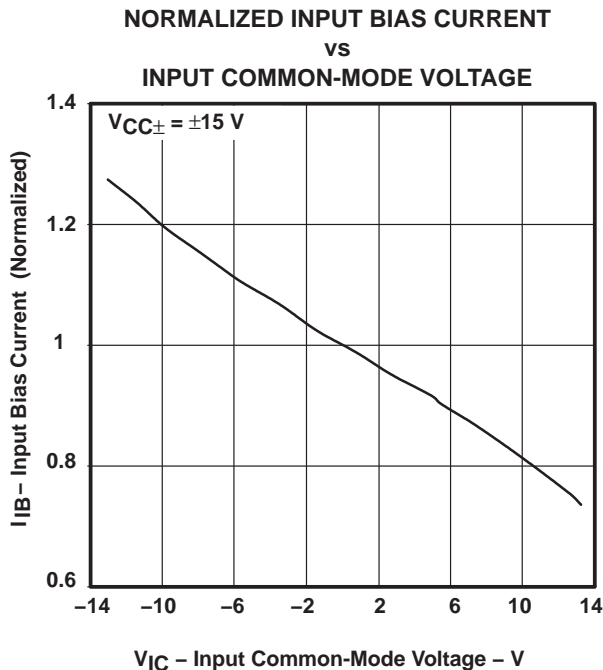

Figure 7

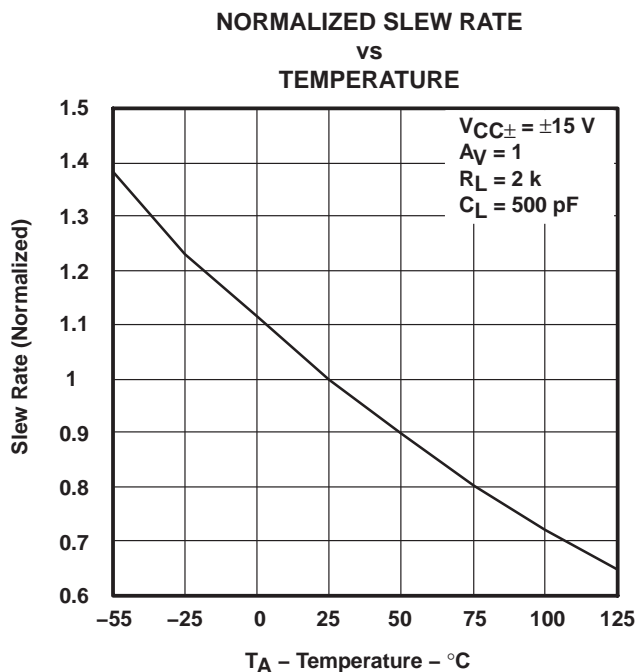

Figure 8

TL3474, TL3474A HIGH-SLEW-RATE, SINGLE-SUPPLY OPERATIONAL AMPLIFIERS

SLVS461B – JANUARY 2003 – REVISED JULY 2003

TYPICAL CHARACTERISTICS ($T_A = 25^\circ\text{C}$ UNLESS OTHERWISE NOTED)

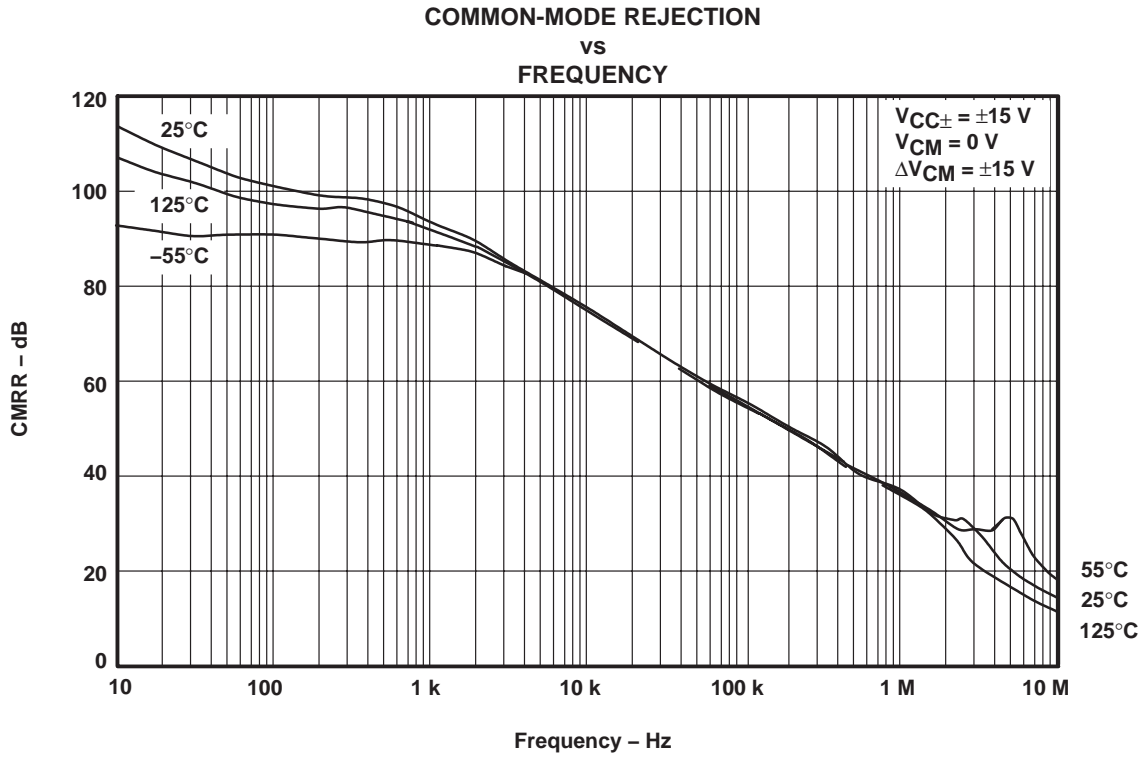

Figure 9

PACKAGING INFORMATION

Orderable Device	Status ⁽¹⁾	Package Type	Package Drawing	Pins	Package Qty	Eco Plan ⁽²⁾	Lead/Ball Finish	MSL Peak Temp ⁽³⁾
TL3474ACD	ACTIVE	SOIC	D	14	50	Green (RoHS & no Sb/Br)	CU NIPDAU	Level-1-260C-UNLIM
TL3474ACDE4	ACTIVE	SOIC	D	14	50	Green (RoHS & no Sb/Br)	CU NIPDAU	Level-1-260C-UNLIM
TL3474ACDG4	ACTIVE	SOIC	D	14	50	Green (RoHS & no Sb/Br)	CU NIPDAU	Level-1-260C-UNLIM
TL3474ACDR	ACTIVE	SOIC	D	14	2500	Green (RoHS & no Sb/Br)	CU NIPDAU	Level-1-260C-UNLIM
TL3474ACDRE4	ACTIVE	SOIC	D	14	2500	Green (RoHS & no Sb/Br)	CU NIPDAU	Level-1-260C-UNLIM
TL3474ACDRG4	ACTIVE	SOIC	D	14	2500	Green (RoHS & no Sb/Br)	CU NIPDAU	Level-1-260C-UNLIM
TL3474ACN	ACTIVE	PDIP	N	14	25	Pb-Free (RoHS)	CU NIPDAU	N / A for Pkg Type
TL3474ACNE4	ACTIVE	PDIP	N	14	25	Pb-Free (RoHS)	CU NIPDAU	N / A for Pkg Type
TL3474ACPW	ACTIVE	TSSOP	PW	14	90	Green (RoHS & no Sb/Br)	CU NIPDAU	Level-1-260C-UNLIM
TL3474ACPWE4	ACTIVE	TSSOP	PW	14	90	Green (RoHS & no Sb/Br)	CU NIPDAU	Level-1-260C-UNLIM
TL3474ACPWG4	ACTIVE	TSSOP	PW	14	90	Green (RoHS & no Sb/Br)	CU NIPDAU	Level-1-260C-UNLIM
TL3474ACPWR	ACTIVE	TSSOP	PW	14	2000	Green (RoHS & no Sb/Br)	CU NIPDAU	Level-1-260C-UNLIM
TL3474ACPWRE4	ACTIVE	TSSOP	PW	14	2000	Green (RoHS & no Sb/Br)	CU NIPDAU	Level-1-260C-UNLIM
TL3474ACPWRG4	ACTIVE	TSSOP	PW	14	2000	Green (RoHS & no Sb/Br)	CU NIPDAU	Level-1-260C-UNLIM
TL3474AID	ACTIVE	SOIC	D	14	50	Green (RoHS & no Sb/Br)	CU NIPDAU	Level-1-260C-UNLIM
TL3474AIDE4	ACTIVE	SOIC	D	14	50	Green (RoHS & no Sb/Br)	CU NIPDAU	Level-1-260C-UNLIM
TL3474AIDG4	ACTIVE	SOIC	D	14	50	Green (RoHS & no Sb/Br)	CU NIPDAU	Level-1-260C-UNLIM
TL3474AIDR	ACTIVE	SOIC	D	14	2500	Green (RoHS & no Sb/Br)	CU NIPDAU	Level-1-260C-UNLIM
TL3474AIDRE4	ACTIVE	SOIC	D	14	2500	Green (RoHS & no Sb/Br)	CU NIPDAU	Level-1-260C-UNLIM
TL3474AIDRG4	ACTIVE	SOIC	D	14	2500	Green (RoHS & no Sb/Br)	CU NIPDAU	Level-1-260C-UNLIM
TL3474AIN	ACTIVE	PDIP	N	14	25	Pb-Free (RoHS)	CU NIPDAU	N / A for Pkg Type
TL3474AINE4	ACTIVE	PDIP	N	14	25	Pb-Free (RoHS)	CU NIPDAU	N / A for Pkg Type
TL3474AIPW	ACTIVE	TSSOP	PW	14	90	Green (RoHS & no Sb/Br)	CU NIPDAU	Level-1-260C-UNLIM
TL3474AIPWE4	ACTIVE	TSSOP	PW	14	90	Green (RoHS & no Sb/Br)	CU NIPDAU	Level-1-260C-UNLIM
TL3474AIPWG4	ACTIVE	TSSOP	PW	14	90	Green (RoHS & no Sb/Br)	CU NIPDAU	Level-1-260C-UNLIM

Orderable Device	Status ⁽¹⁾	Package Type	Package Drawing	Pins	Package Qty	Eco Plan ⁽²⁾	Lead/Ball Finish	MSL Peak Temp ⁽³⁾
TL3474AIPWR	ACTIVE	TSSOP	PW	14	2000	Green (RoHS & no Sb/Br)	CU NIPDAU	Level-1-260C-UNLIM
TL3474AIPWRE4	ACTIVE	TSSOP	PW	14	2000	Green (RoHS & no Sb/Br)	CU NIPDAU	Level-1-260C-UNLIM
TL3474AIPWRG4	ACTIVE	TSSOP	PW	14	2000	Green (RoHS & no Sb/Br)	CU NIPDAU	Level-1-260C-UNLIM
TL3474CD	ACTIVE	SOIC	D	14	50	Green (RoHS & no Sb/Br)	CU NIPDAU	Level-1-260C-UNLIM
TL3474CDE4	ACTIVE	SOIC	D	14	50	Green (RoHS & no Sb/Br)	CU NIPDAU	Level-1-260C-UNLIM
TL3474CDG4	ACTIVE	SOIC	D	14	50	Green (RoHS & no Sb/Br)	CU NIPDAU	Level-1-260C-UNLIM
TL3474CDR	ACTIVE	SOIC	D	14	2500	Green (RoHS & no Sb/Br)	CU NIPDAU	Level-1-260C-UNLIM
TL3474CDRE4	ACTIVE	SOIC	D	14	2500	Green (RoHS & no Sb/Br)	CU NIPDAU	Level-1-260C-UNLIM
TL3474CDRG4	ACTIVE	SOIC	D	14	2500	Green (RoHS & no Sb/Br)	CU NIPDAU	Level-1-260C-UNLIM
TL3474CN	ACTIVE	PDIP	N	14	25	Pb-Free (RoHS)	CU NIPDAU	N / A for Pkg Type
TL3474CNE4	ACTIVE	PDIP	N	14	25	Pb-Free (RoHS)	CU NIPDAU	N / A for Pkg Type
TL3474CPW	ACTIVE	TSSOP	PW	14	90	Green (RoHS & no Sb/Br)	CU NIPDAU	Level-1-260C-UNLIM
TL3474CPWE4	ACTIVE	TSSOP	PW	14	90	Green (RoHS & no Sb/Br)	CU NIPDAU	Level-1-260C-UNLIM
TL3474CPWG4	ACTIVE	TSSOP	PW	14	90	Green (RoHS & no Sb/Br)	CU NIPDAU	Level-1-260C-UNLIM
TL3474CPWR	ACTIVE	TSSOP	PW	14	2000	Green (RoHS & no Sb/Br)	CU NIPDAU	Level-1-260C-UNLIM
TL3474CPWRE4	ACTIVE	TSSOP	PW	14	2000	Green (RoHS & no Sb/Br)	CU NIPDAU	Level-1-260C-UNLIM
TL3474CPWRG4	ACTIVE	TSSOP	PW	14	2000	Green (RoHS & no Sb/Br)	CU NIPDAU	Level-1-260C-UNLIM
TL3474ID	ACTIVE	SOIC	D	14	50	Green (RoHS & no Sb/Br)	CU NIPDAU	Level-1-260C-UNLIM
TL3474IDE4	ACTIVE	SOIC	D	14	50	Green (RoHS & no Sb/Br)	CU NIPDAU	Level-1-260C-UNLIM
TL3474IDG4	ACTIVE	SOIC	D	14	50	Green (RoHS & no Sb/Br)	CU NIPDAU	Level-1-260C-UNLIM
TL3474IDR	ACTIVE	SOIC	D	14	2500	Green (RoHS & no Sb/Br)	CU NIPDAU	Level-1-260C-UNLIM
TL3474IDRE4	ACTIVE	SOIC	D	14	2500	Green (RoHS & no Sb/Br)	CU NIPDAU	Level-1-260C-UNLIM
TL3474IDRG4	ACTIVE	SOIC	D	14	2500	Green (RoHS & no Sb/Br)	CU NIPDAU	Level-1-260C-UNLIM
TL3474IN	ACTIVE	PDIP	N	14	25	Pb-Free (RoHS)	CU NIPDAU	N / A for Pkg Type
TL3474INE4	ACTIVE	PDIP	N	14	25	Pb-Free (RoHS)	CU NIPDAU	N / A for Pkg Type
TL3474IPW	ACTIVE	TSSOP	PW	14	90	Green (RoHS & no Sb/Br)	CU NIPDAU	Level-1-260C-UNLIM

Orderable Device	Status ⁽¹⁾	Package Type	Package Drawing	Pins	Package Qty	Eco Plan ⁽²⁾	Lead/Ball Finish	MSL Peak Temp ⁽³⁾
TL3474IPWE4	ACTIVE	TSSOP	PW	14	90	Green (RoHS & no Sb/Br)	CU NIPDAU	Level-1-260C-UNLIM
TL3474IPWG4	ACTIVE	TSSOP	PW	14	90	Green (RoHS & no Sb/Br)	CU NIPDAU	Level-1-260C-UNLIM
TL3474IPWR	ACTIVE	TSSOP	PW	14	2000	Green (RoHS & no Sb/Br)	CU NIPDAU	Level-1-260C-UNLIM
TL3474IPWRE4	ACTIVE	TSSOP	PW	14	2000	Green (RoHS & no Sb/Br)	CU NIPDAU	Level-1-260C-UNLIM
TL3474IPWRG4	ACTIVE	TSSOP	PW	14	2000	Green (RoHS & no Sb/Br)	CU NIPDAU	Level-1-260C-UNLIM

⁽¹⁾ The marketing status values are defined as follows:

ACTIVE: Product device recommended for new designs.

LIFEBUY: TI has announced that the device will be discontinued, and a lifetime-buy period is in effect.

NRND: Not recommended for new designs. Device is in production to support existing customers, but TI does not recommend using this part in a new design.

PREVIEW: Device has been announced but is not in production. Samples may or may not be available.

OBsolete: TI has discontinued the production of the device.

⁽²⁾ Eco Plan - The planned eco-friendly classification: Pb-Free (RoHS), Pb-Free (RoHS Exempt), or Green (RoHS & no Sb/Br) - please check <http://www.ti.com/productcontent> for the latest availability information and additional product content details.

TBD: The Pb-Free/Green conversion plan has not been defined.

Pb-Free (RoHS): TI's terms "Lead-Free" or "Pb-Free" mean semiconductor products that are compatible with the current RoHS requirements for all 6 substances, including the requirement that lead not exceed 0.1% by weight in homogeneous materials. Where designed to be soldered at high temperatures, TI Pb-Free products are suitable for use in specified lead-free processes.

Pb-Free (RoHS Exempt): This component has a RoHS exemption for either 1) lead-based flip-chip solder bumps used between the die and package, or 2) lead-based die adhesive used between the die and leadframe. The component is otherwise considered Pb-Free (RoHS compatible) as defined above.

Green (RoHS & no Sb/Br): TI defines "Green" to mean Pb-Free (RoHS compatible), and free of Bromine (Br) and Antimony (Sb) based flame retardants (Br or Sb do not exceed 0.1% by weight in homogeneous material)

⁽³⁾ MSL, Peak Temp. -- The Moisture Sensitivity Level rating according to the JEDEC industry standard classifications, and peak solder temperature.

Important Information and Disclaimer: The information provided on this page represents TI's knowledge and belief as of the date that it is provided. TI bases its knowledge and belief on information provided by third parties, and makes no representation or warranty as to the accuracy of such information. Efforts are underway to better integrate information from third parties. TI has taken and continues to take reasonable steps to provide representative and accurate information but may not have conducted destructive testing or chemical analysis on incoming materials and chemicals. TI and TI suppliers consider certain information to be proprietary, and thus CAS numbers and other limited information may not be available for release.

In no event shall TI's liability arising out of such information exceed the total purchase price of the TI part(s) at issue in this document sold by TI to Customer on an annual basis.

TAPE AND REEL INFORMATION



QUADRANT ASSIGNMENTS FOR PIN 1 ORIENTATION IN TAPE



*All dimensions are nominal

Device	Package Type	Package Drawing	Pins	SPQ	Reel Diameter (mm)	Reel Width W1 (mm)	A0 (mm)	B0 (mm)	K0 (mm)	P1 (mm)	W (mm)	Pin1 Quadrant
TL3474ACDR	SOIC	D	14	2500	330.0	16.4	6.5	9.0	2.1	8.0	16.0	Q1
TL3474ACPWR	TSSOP	PW	14	2000	330.0	12.4	7.0	5.6	1.6	8.0	12.0	Q1
TL3474AIDR	SOIC	D	14	2500	330.0	16.4	6.5	9.0	2.1	8.0	16.0	Q1
TL3474AIPWR	TSSOP	PW	14	2000	330.0	12.4	7.0	5.6	1.6	8.0	12.0	Q1
TL3474CDR	SOIC	D	14	2500	330.0	16.4	6.5	9.0	2.1	8.0	16.0	Q1
TL3474CPWR	TSSOP	PW	14	2000	330.0	12.4	7.0	5.6	1.6	8.0	12.0	Q1
TL3474IDR	SOIC	D	14	2500	330.0	16.4	6.5	9.0	2.1	8.0	16.0	Q1
TL3474IPWR	TSSOP	PW	14	2000	330.0	12.4	7.0	5.6	1.6	8.0	12.0	Q1

TAPE AND REEL BOX DIMENSIONS



*All dimensions are nominal

Device	Package Type	Package Drawing	Pins	SPQ	Length (mm)	Width (mm)	Height (mm)
TL3474ACDR	SOIC	D	14	2500	333.2	345.9	28.6
TL3474ACPWR	TSSOP	PW	14	2000	346.0	346.0	29.0
TL3474AIDR	SOIC	D	14	2500	333.2	345.9	28.6
TL3474AIPWR	TSSOP	PW	14	2000	346.0	346.0	29.0
TL3474CDR	SOIC	D	14	2500	333.2	345.9	28.6
TL3474CPWR	TSSOP	PW	14	2000	346.0	346.0	29.0
TL3474IDR	SOIC	D	14	2500	333.2	345.9	28.6
TL3474IPWR	TSSOP	PW	14	2000	346.0	346.0	29.0

PW (R-PDSO-G**)

PLASTIC SMALL-OUTLINE PACKAGE

14 PINS SHOWN



4040064/F 01/97

- NOTES: A. All linear dimensions are in millimeters.
 B. This drawing is subject to change without notice.
 C. Body dimensions do not include mold flash or protrusion not to exceed 0,15.
 D. Falls within JEDEC MO-153

D (R-PDSO-G14)

PLASTIC SMALL-OUTLINE PACKAGE



- NOTES:
- A. All linear dimensions are in inches (millimeters).
 - B. This drawing is subject to change without notice.
 - C. Body length does not include mold flash, protrusions, or gate burrs. Mold flash, protrusions, or gate burrs shall not exceed .006 (0,15) per end.
 - D. Body width does not include interlead flash. Interlead flash shall not exceed .017 (0,43) per side.
 - E. Reference JEDEC MS-012 variation AB.

N (R-PDIP-T**)

PLASTIC DUAL-IN-LINE PACKAGE

16 PINS SHOWN



- NOTES:
- A. All linear dimensions are in inches (millimeters).
 - B. This drawing is subject to change without notice.
 - Falls within JEDEC MS-001, except 18 and 20 pin minimum body length (Dim A).
 - The 20 pin end lead shoulder width is a vendor option, either half or full width.

IMPORTANT NOTICE

Texas Instruments Incorporated and its subsidiaries (TI) reserve the right to make corrections, modifications, enhancements, improvements, and other changes to its products and services at any time and to discontinue any product or service without notice. Customers should obtain the latest relevant information before placing orders and should verify that such information is current and complete. All products are sold subject to TI's terms and conditions of sale supplied at the time of order acknowledgment.

TI warrants performance of its hardware products to the specifications applicable at the time of sale in accordance with TI's standard warranty. Testing and other quality control techniques are used to the extent TI deems necessary to support this warranty. Except where mandated by government requirements, testing of all parameters of each product is not necessarily performed.

TI assumes no liability for applications assistance or customer product design. Customers are responsible for their products and applications using TI components. To minimize the risks associated with customer products and applications, customers should provide adequate design and operating safeguards.

TI does not warrant or represent that any license, either express or implied, is granted under any TI patent right, copyright, mask work right, or other TI intellectual property right relating to any combination, machine, or process in which TI products or services are used. Information published by TI regarding third-party products or services does not constitute a license from TI to use such products or services or a warranty or endorsement thereof. Use of such information may require a license from a third party under the patents or other intellectual property of the third party, or a license from TI under the patents or other intellectual property of TI.

Reproduction of TI information in TI data books or data sheets is permissible only if reproduction is without alteration and is accompanied by all associated warranties, conditions, limitations, and notices. Reproduction of this information with alteration is an unfair and deceptive business practice. TI is not responsible or liable for such altered documentation. Information of third parties may be subject to additional restrictions.

Resale of TI products or services with statements different from or beyond the parameters stated by TI for that product or service voids all express and any implied warranties for the associated TI product or service and is an unfair and deceptive business practice. TI is not responsible or liable for any such statements.

TI products are not authorized for use in safety-critical applications (such as life support) where a failure of the TI product would reasonably be expected to cause severe personal injury or death, unless officers of the parties have executed an agreement specifically governing such use. Buyers represent that they have all necessary expertise in the safety and regulatory ramifications of their applications, and acknowledge and agree that they are solely responsible for all legal, regulatory and safety-related requirements concerning their products and any use of TI products in such safety-critical applications, notwithstanding any applications-related information or support that may be provided by TI. Further, Buyers must fully indemnify TI and its representatives against any damages arising out of the use of TI products in such safety-critical applications.

TI products are neither designed nor intended for use in military/aerospace applications or environments unless the TI products are specifically designated by TI as military-grade or "enhanced plastic." Only products designated by TI as military-grade meet military specifications. Buyers acknowledge and agree that any such use of TI products which TI has not designated as military-grade is solely at the Buyer's risk, and that they are solely responsible for compliance with all legal and regulatory requirements in connection with such use.

TI products are neither designed nor intended for use in automotive applications or environments unless the specific TI products are designated by TI as compliant with ISO/TS 16949 requirements. Buyers acknowledge and agree that, if they use any non-designated products in automotive applications, TI will not be responsible for any failure to meet such requirements.

Following are URLs where you can obtain information on other Texas Instruments products and application solutions:

Products

Amplifiers	amplifier.ti.com
Data Converters	dataconverter.ti.com
DSP	dsp.ti.com
Clocks and Timers	www.ti.com/clocks
Interface	interface.ti.com
Logic	logic.ti.com
Power Mgmt	power.ti.com
Microcontrollers	microcontroller.ti.com
RFID	www.ti-rfid.com
RF/IF and ZigBee® Solutions	www.ti.com/lprf

Applications

Audio	www.ti.com/audio
Automotive	www.ti.com/automotive
Broadband	www.ti.com/broadband
Digital Control	www.ti.com/digitalcontrol
Medical	www.ti.com/medical
Military	www.ti.com/military
Optical Networking	www.ti.com/opticalnetwork
Security	www.ti.com/security
Telephony	www.ti.com/telephony
Video & Imaging	www.ti.com/video
Wireless	www.ti.com/wireless

Mailing Address: Texas Instruments, Post Office Box 655303, Dallas, Texas 75265
Copyright © 2008, Texas Instruments Incorporated